

SUPERLOC[®] SHEET PILE & SUPERWALE[®] SYSTEMS



BUILD LONG-LASTING SHORELINE AND ASSET PROTECTION WITH STORMSTRONG[®] SHEET PILE SYSTEM



Testing at Creative Composites Group
Alum Bank, PA

Mechanical & Physical Properties

Moment Capacity Analysis and Verification

The published moment capacities were derived by utilizing the local buckling equations depicted in the "Pre-Standard for Load & Resistance Factor Design (LRFD) of Pultruded Fiber Reinforced Polymer (FRP) Structures" that has been developed by The American Composites Manufacturing Association (ACMA) in conjunction with the American Society of Civil Engineers (ASCE).

The moment capacity of the sheet pile sections have been validated with Finite Element Analysis (FEA) and full section testing. The analysis and results for the 1580 seawall profile can be scrutinized in the white paper titled Development of Design Properties for the Series 1580 Seawall Profile. The paper describes the equations used to predict the local compression buckling capacity, which is the normal mode of failure for thin walled slender FRP profiles. The predicted results were compared against an FEA and a full section cantilever wall test that was conducted by West Virginia University. CCG's engineering team predicted results that were within $\pm 4\%$ of the full section test conducted on the 1580 cantilever wall.

SuperLoc Sheet Piles

The mechanical and physical data detailed herein is provided for the structural engineer. The mechanical data is published in terms of average and characteristic values. The characteristic values were derived per the requirements as set forth in ASTM D7290-06 "Standard Practice for Evaluating Material Property Characteristic Values for Polymeric Composites for Civil Engineering Structural Applications". The characteristic value is defined as a statistically based material property representing the 80% lower confidence bound on the 5th-percentile value of a specified population. The characteristic value accounts for statistical uncertainty due to a finite sample size. The characteristic value is the reference strength.

In September of 2006, ASTM D7290-06 "Standard Practice for Evaluating Material Property Characteristic Values for Polymeric Composites for Civil Engineering Structural Applications" was published. Until the development of the ASTM D7290-06 Standard, manufacturers of pultruded members, could present their data, in the format of their choice. The standard protects both manufacturers and engineers, as it provides statistical based data that rewards

tight process control. It also gives engineers the comfort that the data was derived per a world-recognized standard. The adoption of the ASTM D7290-06 Standard dictates that every manufacturer must present their data based on a characteristic value. The characteristic values determined using the ASTM D7290-06 Standard can be used to calculate structural member resistance values in design codes for composite civil engineering structures and for establishing limits upon which qualification and acceptance criteria can be based. The data presented in the SuperLoc Data Sheets was developed per the ASTM D7290-06 Standard.

Engineering Your Bulkhead

Creative Composites Group provides both coupon level and full section mechanical and physical properties so the design professional can properly design a bulkhead utilizing the SuperLoc product line. There are two accepted methodologies for designing structures with pultruded profiles. They include Allowable Stress Design (ASD) and Load & Resistance Factor Design (LRFD).

Industry standard ASD safety factors range from 2.0 to 2.5 for flexural stresses and 3.0 for shear and connection stresses.

In terms of LRFD design, the reference strength shall be adjusted for end use conditions by applying the applicable adjustment factors to establish the nominal resistance strength. The design strength shall consist of the nominal resistance strength with the inclusion of a resistance factor and a time effect factor. (For more details into this design approach, please reference the Pre-Standard for Load & Resistance Factor Design (LRFD) of Pultruded Fiber Reinforced Polymer (FRP) Structures.)

The moment capacities published in the property charts are derived utilizing the local compression flange buckling capacity equation in the LRFD pre-standard. These values should be used for both LRFD and ASD analysis approaches.

Serviceability should be checked using realistic loads for the serviceability limit state of concern. The average full section modulus of elasticity should be used for calculating deflections of the sheet pile wall system and components. The average full section modulus of elasticity published in the property charts is based on the lesser value of the average compression or tensile modulus of elasticity derived from coupons extracted from the flange and web sections of the sheet pile. Note that the modulus should be adjusted for long term performance in water by utilizing the modulus reduction factors provided.

Highly Concentrated Loads On Your Bulkhead

Concentrated loads or point loads, applied to composite materials, need to be scrutinized. Specifically, although FRP materials exhibit very high-strengths, the modulus of elasticity is relatively low compared to steel. Therefore, the engineer of record is encouraged to analyze the stresses induced into the sheet pile sections from concentrated loads. A prime example is the stress induced into a FRP bulkhead from the wale. The wale section is essentially concentrating a large amount of the total wall load into the sheet. A highly concentrated wale load could cause the webs to fracture or buckle. CCG publishes the characteristic web buckling capacity for each sheet for the engineer to consider. Appropriate factors must be applied to derive the design capacity.



Coupon Testing, CCG



Full section test of a 1580 sheet pile wall at CCG by WVU. Note: The strain gauge instrumentation.

StormStrong Construction

SuperLoc StormStrong sheet piling is engineered with electrical-grade fiberglass and high-strength resins. The combination of the advanced resin and high-strength glass produces a superior, highly corrosion-resistant sheet pile. SuperLoc has been engineered to withstand storm surges and protect coastal property from extreme weather patterns caused by climate change.

ADVANCED UV PROTECTION

UV rays and heat from solar radiation degrade the molecular structure of most materials. The extent of degradation ranges from mere fading to reduction in strength. Additives in the form of ultraviolet light absorbers and inhibitors greatly increase the performance in long term sunlight exposure. Polyester synthetic veils are applied to the SuperLoc in order to encapsulate the E-glass fibers and provide a resin rich surface.

Results have shown that UV degradation does not affect the modulus of elasticity. Fading of the polymerized resin will occur at various rates over time. Typically, within three years the gloss is eliminated and a visual whitening or yellowing can be observed on the surface. In general, the amount of sunlight and intensity will depend on the geographical location. Therefore, the rate at which composite materials will lighten is variable. The SuperLoc system utilizes the most

advanced resin technology and pigmentation to ensure the best possible aesthetics over time.

CCG's StormStrong sheet piles are shipped standard with two layers of Ultra Violet (UV) protection. First, CCG adds UV light absorbers to each sheet pile. The UV light absorbers are mixed into the thermoset resin, prior to production, and function as long term thermal and light stability promoters. Second, the composite sheet piles are encompassed with a 10 mil polyester surfacing veil. The 10 mil veil creates a resin rich surface and protects the glass reinforcements from fiber blooming.

STORMSTRONG FIBER REINFORCEMENTS

All composite sheet piles are manufactured with electrical-grade E-glass reinforcements in the form of unidirectional roving, Continuous Filament Mat (CFM) and stitched fabric mats. The combination of fiber reinforcements has been engineered for optimal bending strength, as well as superior stiffness. All E-glass reinforcements meet a minimum tensile strength of 290 ksi per ASTM D2343.

ADVANCED RESIN/MATRIX OPTIONS

CCG manufactures the SuperLoc sheet piles and accessories in both isophthalic polyester (Polyester) and vinyl ester (VE) resin formulations. Proper resin selection should be based on the environmental aspects of the site conditions including the soil and water pH and chemical exposure.

Polyester pultrusions are manufactured for corrosion related applications. Polyester resins display excellent structural properties and are resistant to acids, salts, and many dilute chemicals at moderate temperatures. They perform well in acidic environments; however, Polyester pultrusions are not recommended for caustic or alkaline environments. The pH should be kept below 10.5. Oxidizing environments usually present limitations. A long service life can be expected for waterfront environments in salt and fresh water.

VE Resins are based on bisphenol-A epoxy resin. VE resins provide resistance to a wide range of acids, alkalis, bleaches and solvents for use in many chemical environments. They also offer excellent toughness and fatigue resistance. The mechanical properties are typically 10% to 15% higher than polyester properties. A long service life can be expected for waterfront environments in salt and fresh water.

COLOR

SuperLoc and its accessories come standard in graphite gray, the color that has been selected for both its aesthetics and UV performance. Custom colors are available upon request. Minimum quantities and color match charges apply.



StormStrong System Testing

The SuperLoc StormStrong system has undergone extensive testing at Pennsylvania State University, West Virginia University (WVU) and the University of Akron. Testing ranged from full section to coupon to internationally recognized ASTM standards when applicable.



Sheet Pile Design Examples

We are often asked about sheet pile wall design and how we have derived our capacities. In the example(s) below, we will walk you through the design calculations for a sheet pile wall based on several criteria.

Please be advised that history has shown there is some misleading information in the pultruded sheet piling industry. The information pertains to mechanical properties that are published that are not relevant to pultruded sheet pile design. YOU, the Engineer of Record (EOR) need to ensure that you are utilizing the correct information for your design.

For example, most engineers that have bulkhead design experience are accustomed to utilizing yield strength and section modulus for establishing the moment capacity (Typically utilized in Steel designs.) Pultruded sheet piles exhibit very high tension and compression strengths as compared to steel. However, the modulus of elasticity is typically 1/6 that of steel...

Given the slenderness ratio in combination with the lower modulus, pultruded sheet pile sections fail in local compression buckling well before the ultimate compression or tension strength has been reached. Therefore, engineers are cautioned not to use the section modulus in combination with the ultimate tension or compression strength, but rather utilize the local compression buckling strength in combination with the section modulus to obtain the UNFACTORED MOMENT CAPACITY.

FOR ALL FRP DESIGNS, your design will generally be dictated by the MAXIMUM MOMENT capacity of the sheet or deflection.

Design Example Parameters

CREATIVE COMPOSITES GROUP SERIES 1580 SHEET PILE

Section Modulus (13.08 in³/ft),
 Moment of Inertia (54.01 in⁴/ft),
 Average Full Section Modulus of Elasticity 4.41E+06 psi.
 Exposed wall height of 5' from mudline to top of the wall

Sheet length = 10' (We typically recommend a 1/2 in and 1/2 out minimum value, so typically the sheet length would be double the distance from the mudline to the top of the wall.) Geotechnical soil data will dictate the length of the sheet required below the mudline.

Soils = dense coarse sand
 Live Loads = None

Water placement = -1 foot from top of wall (The water placement is often slid up or down to accommodate the loading capacity on the wall and the maximum load on the wale based on tie-rod spacing, etc.)

Passive water level = -2 feet below the top of the sheet pile wall.
 Active water level = -1 foot below the top of the sheet pile wall.
 FOR BOTH ASD AND LRFD FRP DESIGNS, when determining the modulus, moment, shear, and web buckling capacities a Moisture Adjustment Factor (CM) shall be applied according to The Pre-Standard for Load & Resistance Factor Design of Pultruded Fiber Reinforced Polymer Structures. Table 2.4-1 (OF THE LRFD PRE-STANDARD) depicts a moisture adjustment factor 0.80 and 0.90 for strength and modulus, respectively.

LRFD/ASD Design Examples

The following LRFD & ASD design example(s) cover the basics of how to utilize the Creative's characteristic design strengths and apply the appropriate safety factors within your calculations.

SPW911 ANALYSIS

We input the aforementioned design parameters into the PileBuck SPW911 program to obtain the applicable shear, moment, and wale force loads.

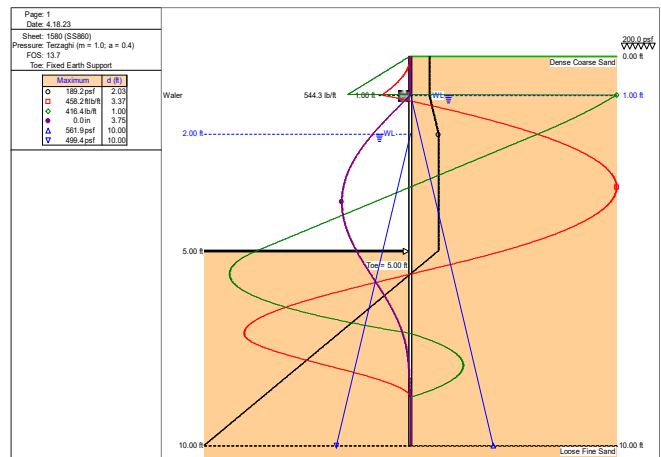

Page 2		Date: 4.18.23		Input Data																																					
Sheet: 1580 (SS860)	Depth Of Excavation = 5.00 ft	Depth Of Active Water = 1.00 ft	Water Density = 62.43 pcf																																						
Pressure: Terzaghi (m = 1.0, a = 0.4)	Surcharge = 200.0 psf	Depth Of Passive Water = 2.00 ft	Minimum Fluid Density = 31.82 pcf																																						
FOS: 13.7	Soil Profile																																								
Top Fixed Earth Support	<table border="1"> <thead> <tr> <th>Depth (ft)</th> <th>Soil Name</th> <th>γ (pcf)</th> <th>γ_{sat} (pcf)</th> <th>C (psf)</th> <th>ϕ (deg)</th> <th>ϕ_{crit} (deg)</th> <th>β (deg)</th> <th>β_{crit} (deg)</th> <th>K_{sc}</th> <th>K_{cs}</th> <th>K_{ϕ}</th> </tr> </thead> <tbody> <tr> <td>0.00</td> <td>Dense Coarse Sand</td> <td>115.52</td> <td>68.70</td> <td>0.0</td> <td>0.0</td> <td>40.0</td> <td>0.0</td> <td>0.22</td> <td>0.00</td> <td>4.69</td> <td>0.00</td> </tr> <tr> <td>10.00</td> <td>Loose Fine Sand</td> <td>109.20</td> <td>65.55</td> <td>0.0</td> <td>0.0</td> <td>30.0</td> <td>0.0</td> <td>0.33</td> <td>0.00</td> <td>3.00</td> <td>0.00</td> </tr> </tbody> </table>					Depth (ft)	Soil Name	γ (pcf)	γ_{sat} (pcf)	C (psf)	ϕ (deg)	ϕ_{crit} (deg)	β (deg)	β_{crit} (deg)	K_{sc}	K_{cs}	K_{ϕ}	0.00	Dense Coarse Sand	115.52	68.70	0.0	0.0	40.0	0.0	0.22	0.00	4.69	0.00	10.00	Loose Fine Sand	109.20	65.55	0.0	0.0	30.0	0.0	0.33	0.00	3.00	0.00
Depth (ft)	Soil Name	γ (pcf)	γ_{sat} (pcf)	C (psf)	ϕ (deg)	ϕ_{crit} (deg)	β (deg)	β_{crit} (deg)	K_{sc}	K_{cs}	K_{ϕ}																														
0.00	Dense Coarse Sand	115.52	68.70	0.0	0.0	40.0	0.0	0.22	0.00	4.69	0.00																														
10.00	Loose Fine Sand	109.20	65.55	0.0	0.0	30.0	0.0	0.33	0.00	3.00	0.00																														
Solution																																									
<table border="1"> <thead> <tr> <th>Sheet Name</th> <th>I (in⁴/ft)</th> <th>E (psi)</th> <th>Z (in/ft)</th> <th>I (in⁴)</th> <th>Maximum Bending Moment (ft-kip)</th> <th>Upstand (ft)</th> <th>Toe (ft)</th> <th>Length (ft)</th> </tr> </thead> <tbody> <tr> <td>1580 (SS860)</td> <td>54.01</td> <td>3,91E+06</td> <td>13.08</td> <td>0.0</td> <td>14904.1</td> <td>0.00</td> <td>5.00</td> <td>10.00</td> </tr> </tbody> </table>						Sheet Name	I (in ⁴ /ft)	E (psi)	Z (in/ft)	I (in ⁴)	Maximum Bending Moment (ft-kip)	Upstand (ft)	Toe (ft)	Length (ft)	1580 (SS860)	54.01	3,91E+06	13.08	0.0	14904.1	0.00	5.00	10.00																		
Sheet Name	I (in ⁴ /ft)	E (psi)	Z (in/ft)	I (in ⁴)	Maximum Bending Moment (ft-kip)	Upstand (ft)	Toe (ft)	Length (ft)																																	
1580 (SS860)	54.01	3,91E+06	13.08	0.0	14904.1	0.00	5.00	10.00																																	
Load Model: Area Distribution																																									
Supports																																									
<table border="1"> <thead> <tr> <th>Depth (ft)</th> <th>Type</th> <th>Linear Load (kip/ft)</th> <th>Maxima</th> </tr> </thead> <tbody> <tr> <td>1.00</td> <td>Water</td> <td>544.3</td> <td> <table border="1"> <thead> <tr> <th>Maximum</th> <th>Depth</th> </tr> </thead> <tbody> <tr> <td>Bending Moment</td> <td>486.2 ft-kip</td> </tr> <tr> <td>Deflection</td> <td>0.0in</td> </tr> <tr> <td>Pressure</td> <td>189.2 psf</td> </tr> <tr> <td>Shear Force</td> <td>416.4 kip</td> </tr> </tbody> </table> </td> </tr> </tbody> </table>						Depth (ft)	Type	Linear Load (kip/ft)	Maxima	1.00	Water	544.3	<table border="1"> <thead> <tr> <th>Maximum</th> <th>Depth</th> </tr> </thead> <tbody> <tr> <td>Bending Moment</td> <td>486.2 ft-kip</td> </tr> <tr> <td>Deflection</td> <td>0.0in</td> </tr> <tr> <td>Pressure</td> <td>189.2 psf</td> </tr> <tr> <td>Shear Force</td> <td>416.4 kip</td> </tr> </tbody> </table>	Maximum	Depth	Bending Moment	486.2 ft-kip	Deflection	0.0in	Pressure	189.2 psf	Shear Force	416.4 kip																		
Depth (ft)	Type	Linear Load (kip/ft)	Maxima																																						
1.00	Water	544.3	<table border="1"> <thead> <tr> <th>Maximum</th> <th>Depth</th> </tr> </thead> <tbody> <tr> <td>Bending Moment</td> <td>486.2 ft-kip</td> </tr> <tr> <td>Deflection</td> <td>0.0in</td> </tr> <tr> <td>Pressure</td> <td>189.2 psf</td> </tr> <tr> <td>Shear Force</td> <td>416.4 kip</td> </tr> </tbody> </table>	Maximum	Depth	Bending Moment	486.2 ft-kip	Deflection	0.0in	Pressure	189.2 psf	Shear Force	416.4 kip																												
Maximum	Depth																																								
Bending Moment	486.2 ft-kip																																								
Deflection	0.0in																																								
Pressure	189.2 psf																																								
Shear Force	416.4 kip																																								

ASD Solution

Reference the SuperLoc Series 1580 (SS860) made with polyester resin datasheet mechanical properties table.

These tables (pages 12-13) depict the characteristic shear strength, moment capacity, and web buckling capacity from the wale force. The values are:

- Characteristic shear strength = 26,321 lbs./ft of wall,
- Moment capacity = 14,904 lb.-ft/ft. of wall,
- Web buckling capacity from the wale force = 2,376 lbs./ft of wall

**For members in bending, the Pultrusion industry-recognized safety factors are typically 2.0 to 2.5 for flexure and 3.0 for shear.*

To obtain the allowable shear capacity, divide the shear strength characteristic design value by a safety factor of three.

For example:

Allowable shear capacity $\sim 26,321 * 0.8 / 3.0 = 7,019$ lbs. per ft. of wall.

Factor the moment capacity by applying YOUR SAFETY FACTOR.

Again, the Pultrusion industry recommends a 2.5 safety factor; however, some engineers choose to utilize a 2.0 Factor of Safety. For the design example below, we will illustrate a Factor of Safety of 2.5.

For example:

Moment capacity $\sim 14,904 * 0.8 / 2.5$ safety factor = 4,769 ft-lb/ft. of wall.

Additionally, you SHOULD APPLY a 2.5 safety factor to the allowable web buckling capacity from the wale force published value for SuperLoc Series 1580.

For example:

Maximum Wale Force $\sim 2,376 * 0.8 / 2.5$ safety factor = 760 lbs./ft of wall.

Based on the above outputs, the design strength/capacity of the SuperLoc Series 1580 sheet is greater than or equal to the forces calculated in the SPW911 software analysis.

SPW911 PREDICTED THE FOLLOWING

The design shear strength of the SuperLoc Series 1580 sheet is 7,019 lb./ft of wall.

The SPW 911 program predicted a shear force of 416.4 lb./ft of wall.

Therefore, the shear capacity is adequate.

The design moment capacity of the SuperLoc Series 1580 sheet is 4,769 ft-lb/ft. of wall.

The SPW 911 program predicted a moment of 458.2 ft-lb/ft of wall.

Therefore, the moment capacity of the SuperLoc Series 1580 sheet is adequate.

The factored web buckling capacity from the wale force published value for SuperLoc Series 1580 is 760 lbs./ft.

The SPW 911 predicted wale force per foot of wale is 544.3 lbs./ft.

Therefore, the SuperLoc Series 1580 sheet is adequate.

LRFD Design example (utilizing PileBuck SPW911)

Per the design parameters above, the SPW911 analysis below shows a cross-section view of a SuperLoc Series 1580 (SS860) sheet pile section that is 10ft long and driven into dense coarse sand. The wale connecting the sheet pile wall is located one foot below the top of the wall. The active and passive water level are one and two feet below the top of the wall, respectively. From the top of the wall to the mudline, it is assumed to be five feet.

Utilizing the PileBuck program (SPW911) the following loading was predicted:

Applied shear force = 416.4 lb./ft

Bending moment = 458.2 ft-lb/ft

Wale force = 544.3 lb./ft

LRFD Solution

Reference the SuperLoc Series 1580 (SS860) polyester resin datasheet, mechanical properties table.

The characteristic polyester shear strength, moment capacity, and web buckling from the wale force are:

Shear strength is 26,321 lbs. per ft. of wall,

Moment capacity, 14,904 lb.-ft/ft. of wall,

Web buckling from the wale force 2,376 lbs./ft of wall

When determining the allowable moment, shear, and web buckling capacities via the LRFD method, a Load Combination, Time Effect Factor (λ) and Resistance Factor (Φ) shall be applied according to The Pre-Standard for Load & Resistance Factor Design of Pultruded Fiber Reinforced Polymer Structures.

According to Section 1.5.2.a (OF THE LRFD PRE-STANDARD), where the effect of H loads add to the primary variable load effect, include H with a load factor of 1.6. Table 2.3-1 (OF THE LRFD PRE-STANDARD), for a storage load, a time effect factor ($\lambda=0.6$) shall be applied.

These values WILL need to be applied for shear and moment calculations for polyester resin sheet pile sections. The resistance factor ($\Phi=0.80$) is determined by the governing strength design, in this case, (web shear buckling and compression flange buckling). The resistance side of the equation will need to be divided by the load factor due to software restrictions.

Using the LRFD design, you should obtain:

Allowable shear strength of:

$(26,321*0.6*0.8*0.8) / 1.6 = 6,317$ lbs. per ft. of wall,

Moment capacity of:

$(14,904*0.6*0.8*0.8) / 1.6 = 3,577$ ft-lb/ft. of wall,

Web buckling capacity from the wale force of:

$(2,376*0.6*0.8*0.8) / 1.6 = 570$ lbs./ft of wall.

Again, the design strength of the SuperLoc Series 1580 sheet shall be greater than or equal to the forces calculated in the SPW911 software analysis.

Deflection Calculation

When determining the deflection of a sheet pile wall, the average full section modulus of elasticity or the lesser of the average lengthwise tensile or compression modulus shall be utilized for the modulus of elasticity.

In this example, the SPW911 software analysis predicted a maximum deflection of 0.012 inches.

**SERIES 1432
(SS140)**

Tampa, FL - Wall shown prior to concrete cap install

SuperLoc Sheet Piles - Series 1432 (SS140)

Part drawings and physical property sheets can be viewed at CreativeCompositesGroup.com

Physical & Mechanical Properties

Series 1432 (SS140) 32" (812.8mm) W x 14" (355.6mm) H Physical Properties	Imperial Value	Units	Metric Value	Units
Section Modulus	30.05	in ³ /ft	1615.54	cm ³ /m
Moment of Inertia	240.54	in ⁴ /ft	32848.18	cm ⁴ /m
Typical Thickness	0.340	in	8.636	mm
Depth of Sheet	14.00	in	355.60	mm
Width of Sheet	32.00	in	812.80	mm
Weight (single pile)	18.04	lb/ft of sheet	27.00	kg/m of sheet
Angle of the web	20	°	20	°
Cross Sectional Area of Sheet	22.1	in ²	142.43	cm ²
Standard Color	Graphite Gray			

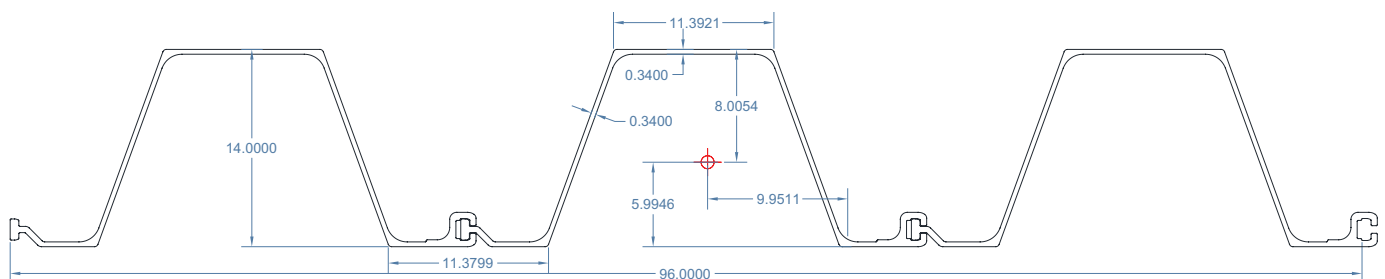

SuperLoc Sheet Piles - Series 1432 (SS140)

Physical & Mechanical Properties

Series 1432 (SS140) 32" (812.8mm) W x 14" (355.6mm) H Mechanical Properties	Test Method	ASTM D7290-06 Characteristic Values				Units
		Polyester Resin		Vinyl Ester Resin		
		Imperial	Metric	Imperial	Metric	
Tensile Modulus (LW)	ASTM D638	3.95	27.23	3.95	27.23	Msi / GPa
Tensile Modulus (CW)	ASTM D638	0.60	4.14	0.60	4.14	Msi / GPa
Compression Modulus (LW)	ASTM D6641	3.34	23.03	3.34	23.03	Msi / GPa
Compression Modulus (CW)	ASTM D6641	1.19	8.20	1.19	8.20	Msi / GPa
Tensile Strength (LW)	ASTM D638	69.97	482.43	69.97	482.43	ksi / MPa
Tensile Strength (CW)	ASTM D638	8.37	57.71	8.37	57.71	ksi / MPa
Compression Strength (LW)	ASTM D6641	62.96	434.11	62.96	434.11	ksi / MPa
Compression Strength (CW)	ASTM D6641	19.44	134.06	19.44	134.06	ksi / MPa
Inplane Shear Strength	ASTM D5379	8.75	60.29	8.75	60.29	ksi / MPa
Inplane Shear Modulus	ASTM D5379	0.71	4.90	0.71	4.90	Msi / GPa
Short Beam Shear Strength	ASTM D2344	3.39	23.35	3.39	23.35	ksi / MPa
Series 1432 (SS140) 32" (812.8mm) W x 14" (355.6mm) H Mechanical Properties						
Moment Capacity		Imperial		Metric		
Moment Capacity Polyester ⁽¹⁾		74,165 lb-ft/ft. of wall		329.9 kN-m/meter of wall		
Moment Capacity Vinyl Ester ⁽¹⁾		74,165 lb-ft/ft. of wall		329.9 kN-m/meter of wall		
Shear Strength		Imperial		Metric		
Shear Strength Polyester ⁽¹⁾		18,403 lbs per ft. of wall		268.6 kN/meter of wall		
Shear Strength Vinyl Ester ⁽¹⁾		18,403 lbs per ft. of wall		268.6 kN/meter of wall		
Full Section Modulus of Elasticity		Imperial		Metric		
Average Full Section Modulus of Elasticity ⁽²⁾		4.66 Msi (Polyester) 4.66 Msi (Vinyl Ester)		32.13 GPa (Polyester) 32.13 GPa (Vinyl Ester)		
Web Buckling Capacity from Wale Force (based on 8" wale section)		12,790 lbs/ft of wall		186.7 kN/m of wall		

Design Notes & Considerations:

¹Ultimate Capacity based on ASTM D 7290-06 Characteristic Values

²Utilize Average Full Section Modulus for Deflection Calculations

The EOR when designing by ASD or LRFD methods shall apply the following factors as applicable:

LRFD & ASD Adjustment Factors (Not applied to values in the table above):

- Polyester Moment Moisture Adjustment Factor = 0.80
- Vinyl Ester Moment Moisture Adjustment Factor = 0.85
- Polyester Shear Moisture Adjustment Factor = 0.80
- Vinyl Ester Shear Moisture Adjustment Factor = 0.85
- Polyester Modulus of Elasticity Moisture Adjustment Factor = 0.90
- Vinyl Ester Modulus of Elasticity Moisture Adjustment Factor = 0.95

LRFD Design Factors (Not applied to values in the table above):

- Time Effect Factor (λ) = 0.40 (Sustained Dead Load)
- Resistance Factor (Φ) = 0.80

ASD Design Factors (Not applied to values above):

- Safety Factors for Moment and Shear Calculations Range from 2.0 - 3.0

Note: All Capacities have been developed based on the equations and design methodologies described in the Pre-Standard Load & Resistance Factor Design (LRFD) of Pultruded Fiber Reinforced Polymer (FRP) Structures (2010).

* Reference design example on pages 6-7 for clarification.

SERIES 1610 (SS819)

Harbor Island, South Carolina

SuperLoc Sheet Piles - Series 1610 (SS819)

Part drawings and physical property sheets can be viewed at CreativeCompositesGroup.com

Physical & Mechanical Properties

Series 1610 (SS819) 24" (609.6mm) W x 10" (254mm) H Physical Properties	Imperial Value	Units	Metric Value	Units
Section Modulus	18.4	in ³ /ft	989.24	cm ³ /m
Moment of Inertia	101.43	in ⁴ /ft	13851.12	cm ⁴ /m
Typical Thickness	0.3	in	7.62	mm
Depth of Sheet	10	in	254	mm
Width of Sheet	24	in	609.6	mm
Weight (single pile)	11.6	lb/ft of sheet	17.26	kg/m of sheet
Angle of the web	20	°	20	°
Cross Sectional Area of Sheet	13.47	in ²	86.9	cm ²
Standard Color	Graphite Gray			

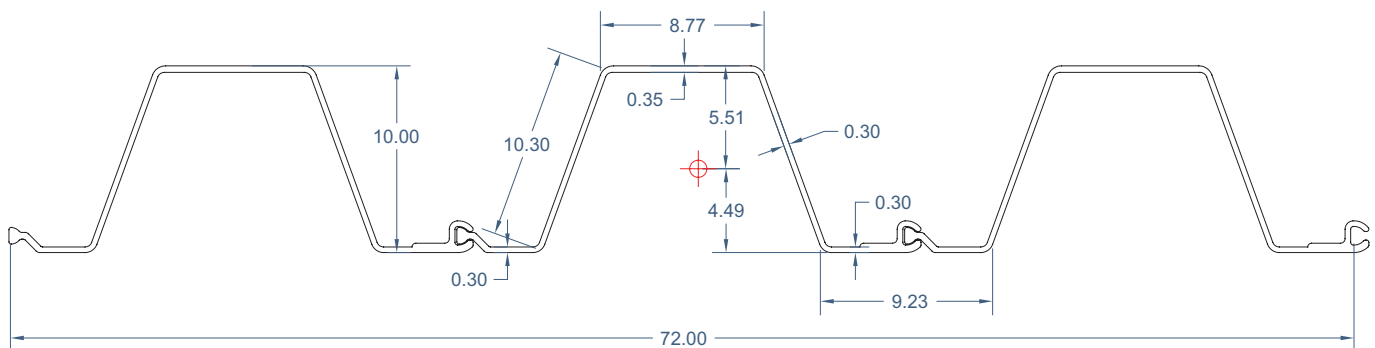

SuperLoc Sheet Piles - Series 1610 (SS819)

Physical & Mechanical Properties

Series 1610 (SS819) 24" (609.6mm) W x 10" (254mm) H Mechanical Properties	Test Method	ASTM D7290-06 Characteristic Values				Units
		Polyester Resin		Vinyl Ester Resin		
		Imperial	Metric	Imperial	Metric	
Tensile Modulus (LW)	ASTM D638	4.34	29.92	5.24	36.13	Msi / GPa
Tensile Modulus (CW)	ASTM D638	0.53	3.65	0.65	4.48	Msi / GPa
Compression Modulus (LW)	ASTM D6641	4.7	32.41	5.43	37.44	Msi / GPa
Compression Modulus (CW)	ASTM D6641	1.33	9.17	0.97	6.69	Msi / GPa
Tensile Strength (LW)	ASTM D638	79.75	549.85	73.98	510.09	ksi / MPa
Tensile Strength (CW)	ASTM D638	4.39	30.29	8.43	58.14	ksi / MPa
Compression Strength (LW)	ASTM D6641	59.1	407.5	58.4	402.66	ksi / MPa
Compression Strength (CW)	ASTM D6641	12.88	88.78	11.85	81.72	ksi / MPa
Inplane Shear Strength	ASTM D5379	3.9	26.86	5.04	34.76	ksi / MPa
Inplane Shear Modulus	ASTM D5379	0.3	2.07	0.35	2.41	Msi / GPa
Short Beam Shear Strength	ASTM D2344	3.39	23.39	3.93	27.1	ksi / MPa
Series 1610 (SS819) 24" (609.6mm) W x 10" (254mm) H Mechanical Properties						
Moment Capacity		Imperial		Metric		
Moment Capacity Polyester ⁽¹⁾		46,180 lb-ft/ft. of wall		205.4 kN-m/meter of wall		
Moment Capacity Vinyl Ester ⁽¹⁾		55,127 lb-ft/ft. of wall		245.2 kN-m/meter of wall		
Shear Strength		Imperial		Metric		
Shear Strength Polyester ⁽¹⁾		19,678 lbs per ft. of wall		287.2 kN/meter of wall		
Shear Strength Vinyl Ester ⁽¹⁾		23,644 lbs per ft. of wall		345.1 kN/meter of wall		
Full Section Modulus of Elasticity		Imperial		Metric		
Average Full Section Modulus of Elasticity ⁽²⁾		5.40 Msi (Polyester) 6.10 Msi (Vinyl Ester)		40.61 GPa (Polyester) 42.06 GPa (Vinyl Ester)		
Web Buckling Capacity from Wale Force (based on 8" wale section)		10,061 lbs/ft of wall		146.8 kN/m of wall		

Design Notes & Considerations:

¹Ultimate Capacity based on ASTM D 7290-06 Characteristic Values

²Utilize Average Full Section Modulus for Deflection Calculations

The EOR when designing by ASD or LRFD methods shall apply the following factors as applicable:

LRFD & ASD Adjustment Factors (Not applied to values in the table above):

- Polyester Moment Moisture Adjustment Factor = 0.80
- Vinyl Ester Moment Moisture Adjustment Factor = 0.85
- Polyester Shear Moisture Adjustment Factor = 0.80
- Vinyl Ester Shear Moisture Adjustment Factor = 0.85
- Polyester Modulus of Elasticity Moisture Adjustment Factor = 0.90
- Vinyl Ester Modulus of Elasticity Moisture Adjustment Factor = 0.95

LRFD Design Factors (Not applied to values in the table above):

- Time Effect Factor (λ) = 0.40 (Sustained Dead Load)
- Resistance Factor (Φ) = 0.80

ASD Design Factors (Not applied to values above):

- Safety Factors for Moment and Shear Calculations Range from 2.0 - 3.0

Note: All Capacities have been developed based on the equations and design methodologies described in the Pre-Standard Load & Resistance Factor Design (LRFD) of Pultruded Fiber Reinforced Polymer (FRP) Structures (2010).

* Reference design example on pages 6-7 for clarification.

**SERIES 1580
(SS860)**

Margate City, NJ

SuperLoc Sheet Piles - Series 1580 (SS860)

Part drawings and physical property sheets can be viewed at CreativeCompositesGroup.com

Physical & Mechanical Properties

Series 1580 (SS860) 18" (457.2mm) W x 8" (203.2mm) H Physical Properties	Imperial Value	Units	Metric Value	Units
Section Modulus	13.08	in ³ /ft	703.22	cm ³ /m
Moment of Inertia	54.01	in ⁴ /ft	7375.52	cm ⁴ /m
Typical Thickness	0.265	in	6.731	mm
Depth of Sheet	8	in	203.2	mm
Width of Sheet	18	in	457.2	mm
Weight (single pile)	6	lb/ft of sheet	8.93	kg/m of sheet
Angle of the web	30	°	30	°
Cross Sectional Area of Sheet	7.43	in ²	47.94	cm ²
Standard Color	Graphite Gray			

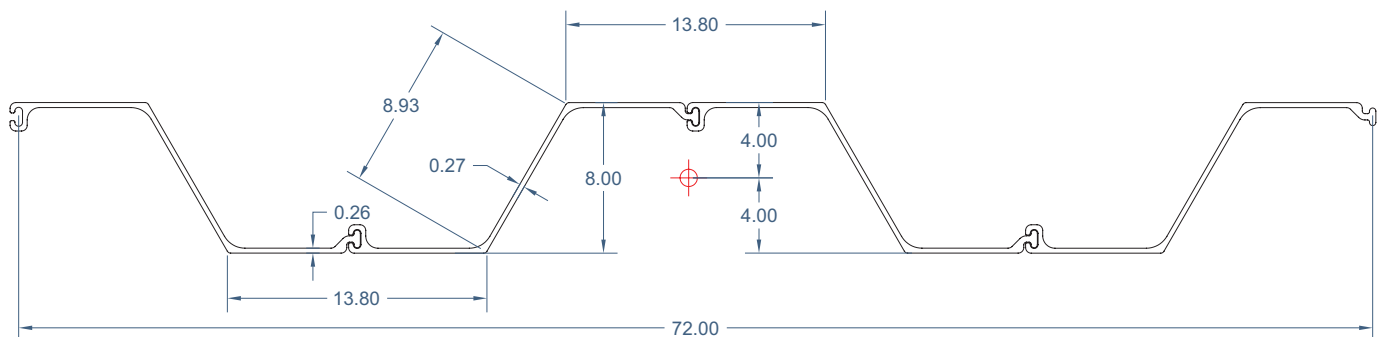

SuperLoc Sheet Piles - Series 1580 (SS860)

Physical & Mechanical Properties

Series 1580 (SS860) 18" (457.2mm) W x 8" (203.2mm) H Mechanical Properties	Test Method	ASTM D7290-06 Characteristic Values				Units
		Polyester Resin		Vinyl Ester Resin		
		Imperial	Metric	Imperial	Metric	
Tensile Modulus (LW)	ASTM D638	3.47	22.96	3.41	23.51	Msi / GPa
Tensile Modulus (CW)	ASTM D638	1.22	8.41	1.45	10	Msi / GPa
Compression Modulus (LW)	ASTM D6641	3.6	24.82	3.27	22.55	Msi / GPa
Compression Modulus (CW)	ASTM D6641	0.88	6.07	1.23	8.48	Msi / GPa
Tensile Strength (LW)	ASTM D638	66.68	459.76	73.42	506.21	ksi / MPa
Tensile Strength (CW)	ASTM D638	6.31	43.53	8.81	60.74	ksi / MPa
Compression Strength (LW)	ASTM D6641	48.69	335.68	54.92	378.66	ksi / MPa
Compression Strength (CW)	ASTM D6641	13.87	95.66	15.05	103.77	ksi / MPa
Inplane Shear Strength	ASTM D5379	4.51	31.1	5.72	39.44	ksi / MPa
Inplane Shear Modulus	ASTM D5379	0.5	3.45	0.5	3.45	Msi / GPa
Short Beam Shear Strength	ASTM D2344	3.79	26.1	4.18	28.82	ksi / MPa
Series 1580 (SS860) 18" (457.2mm) W x 8" (203.2mm) H Mechanical Properties						
Moment Capacity		Imperial		Metric		
Moment Capacity Polyester ⁽¹⁾		14,904 lb-ft/ft. of wall		66.3 kN-m/meter of wall		
Moment Capacity Vinyl Ester ⁽¹⁾		16,795 lb-ft/ft. of wall		74.7 kN-m/meter of wall		
Shear Strength		Imperial		Metric		
Shear Strength Polyester ⁽¹⁾		26,321 lbs per ft. of wall		384.1 kN/meter of wall		
Shear Strength Vinyl Ester ⁽¹⁾		31,203 lbs per ft. of wall		455.4 kN/meter of wall		
Full Section Modulus of Elasticity		Imperial		Metric		
Average Full Section Modulus of Elasticity ⁽²⁾		4.41 Msi (Polyester) 4.56 Msi (Vinyl Ester)		30.41 GPa (Polyester) 31.44 GPa (Vinyl Ester)		
Web Buckling Capacity from Wale Force (based on 8" wale section)		6,253 lbs/ft of wall		91.3 kN/m of wall		

Design Notes & Considerations:

¹Ultimate Capacity based on ASTM D 7290-06 Characteristic Values

²Utilize Average Full Section Modulus for Deflection Calculations

The EOR when designing by ASD or LRFD methods shall apply the following factors as applicable:

LRFD & ASD Adjustment Factors (Not applied to values in the table above):

- Polyester Moment Moisture Adjustment Factor = 0.80
- Vinyl Ester Moment Moisture Adjustment Factor = 0.85
- Polyester Shear Moisture Adjustment Factor = 0.80
- Vinyl Ester Shear Moisture Adjustment Factor = 0.85
- Polyester Modulus of Elasticity Moisture Adjustment Factor = 0.90
- Vinyl Ester Modulus of Elasticity Moisture Adjustment Factor = 0.95

LRFD Design Factors (Not applied to values in the table above):

- Time Effect Factor (λ) = 0.40 (Sustained Dead Load)
- Resistance Factor (Φ) = 0.80

ASD Design Factors (Not applied to values above):

- Safety Factors for Moment and Shear Calculations Range from 2.0 - 3.0

Note: All Capacities have been developed based on the equations and design methodologies described in the Pre-Standard Load & Resistance Factor Design (LRFD) of Pultruded Fiber Reinforced Polymer (FRP) Structures (2010).

* Reference design example on pages 6-7 for clarification.

**SERIES 1560
(SS806)**

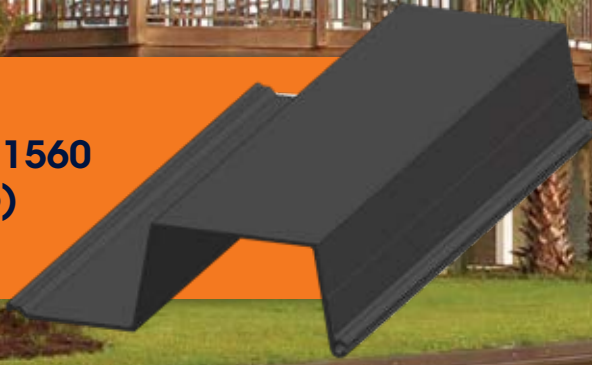

Masonboro Harbour
Wilmington, North Carolina

SuperLoc Sheet Piles - Series 1560 (SS806)

Part drawings and physical property sheets can be viewed at CreativeCompositesGroup.com

Physical & Mechanical Properties

Series 1560 (SS806) 18" (457.2mm) W x 6" (152.4mm) H Physical Properties	Imperial Value	Units	Metric Value	Units
Section Modulus	8.02	in ³ /ft	431.18	cm ³ /m
Moment of Inertia	24.13	in ⁴ /ft	3295.16	cm ⁴ /m
Typical Thickness	0.2	in	5.08	mm
Depth of Sheet	6	in	152.4	mm
Width of Sheet	18	in	457.2	mm
Weight (single pile)	4.82	lb/ft of sheet	7.17	kg/m of sheet
Angle of the web	10	°	10	°
Cross Sectional Area of Sheet	6.17	in ²	39.81	cm ²
Standard Color	Graphite Gray			

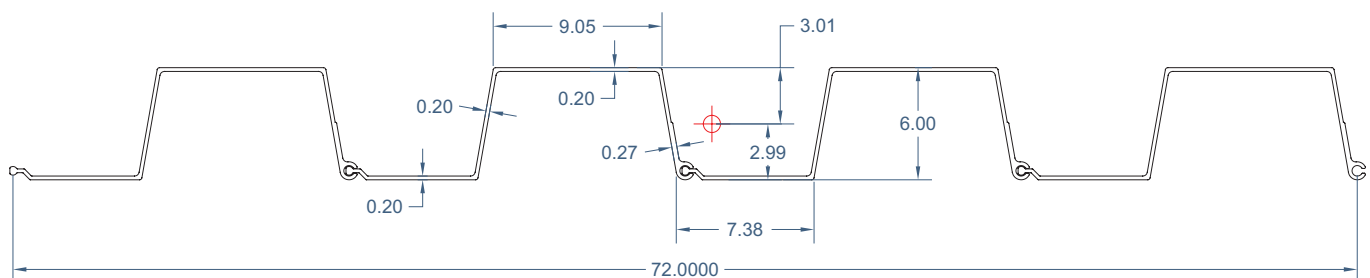

SuperLoc Sheet Piles - Series 1560 (SS806)

Physical & Mechanical Properties

Series 1560 (SS806) 18" (457.2mm) W x 6" (152.4mm) H Mechanical Properties	Test Method	ASTM D7290-06 Characteristic Values				Units
		Polyester Resin		Vinyl Ester Resin		
		Imperial	Metric	Imperial	Metric	
Tensile Modulus (LW)	ASTM D638	2.51	17.31	3.26	22.48	Msi / GPa
Tensile Modulus (CW)	ASTM D638	1.22	8.41	1.46	10.07	Msi / GPa
Compression Modulus (LW)	ASTM D6641	3.08	21.24	3.16	21.79	Msi / GPa
Compression Modulus (CW)	ASTM D6641	0.92	6.34	1.23	8.48	Msi / GPa
Tensile Strength (LW)	ASTM D638	52.15	359.54	58.95	406.45	ksi / MPa
Tensile Strength (CW)	ASTM D638	10.44	71.97	10.13	69.84	ksi / MPa
Compression Strength (LW)	ASTM D6641	40.98	282.51	50.98	351.49	ksi / MPa
Compression Strength (CW)	ASTM D6641	14.98	103.25	19.18	132.24	ksi / MPa
Inplane Shear Strength	ASTM D5379	8.8	60.7	11.04	76.12	ksi / MPa
Inplane Shear Modulus	ASTM D5379	0.42	2.9	0.42	2.9	Msi / GPa
Short Beam Shear Strength	ASTM D2344	4.12	28.43	4.58	31.58	ksi / MPa
Series 1560 (SS806) 18" (457.2mm) W x 6" (152.4mm) H Mechanical Properties						
Moment Capacity		Imperial		Metric		
Moment Capacity Polyester ⁽¹⁾		9,052 lb-ft/ft. of wall		40.3 kN-m/meter of wall		
Moment Capacity Vinyl Ester ⁽¹⁾		10,662 lb-ft/ft. of wall		47.4 kN-m/meter of wall		
Shear Strength		Imperial		Metric		
Shear Strength Polyester ⁽¹⁾		21,041 lbs per ft. of wall		307.1 kN/meter of wall		
Shear Strength Vinyl Ester ⁽¹⁾		24,398 lbs per ft. of wall		356.1 kN/meter of wall		
Full Section Modulus of Elasticity		Imperial		Metric		
Average Full Section Modulus of Elasticity ⁽²⁾		3.62 Msi (Polyester) 3.86 Msi (Vinyl Ester)		25.30 GPa (Polyester) 26.61 GPa (Vinyl Ester)		
Web Buckling Capacity from Wale Force (based on 8" wale section)		5,899 lbs/ft of wall		86.1 kN/m of wall		

Design Notes & Considerations:

¹Ultimate Capacity based on ASTM D 7290-06 Characteristic Values

²Utilize Average Full Section Modulus for Deflection Calculations

The EOR when designing by ASD or LRFD methods shall apply the following factors as applicable:

LRFD & ASD Adjustment Factors (Not applied to values in the table above):

- Polyester Moment Moisture Adjustment Factor = 0.80
- Vinyl Ester Moment Moisture Adjustment Factor = 0.85
- Polyester Shear Moisture Adjustment Factor = 0.80
- Vinyl Ester Shear Moisture Adjustment Factor = 0.85
- Polyester Modulus of Elasticity Moisture Adjustment Factor = 0.90
- Vinyl Ester Modulus of Elasticity Moisture Adjustment Factor = 0.95

LRFD Design Factors (Not applied to values in the table above):

- Time Effect Factor (λ) = 0.40 (Sustained Dead Load)
- Resistance Factor (Φ) = 0.80

ASD Design Factors (Not applied to values above):

- Safety Factors for Moment and Shear Calculations Range from 2.0 - 3.0

Note: All Capacities have been developed based on the equations and design methodologies described in the Pre-Standard Load & Resistance Factor Design (LRFD) of Pultruded Fiber Reinforced Polymer (FRP) Structures (2010).

* Reference design example on pages 6-7 for clarification.

Sheet Pile Caps & Connectors

Each sheet pile profile can be accessorized with FRP caps and connectors. The pultruded channel caps are made of the same durable resins and fiberglass as the sheet pile sections.

CCG recommends that the caps be painted due to the direct UV exposure. Failure to paint the caps will result in fading, loss of gloss and potential fiber blooming over time.

The caps should be secured to the sheet pile sections with stainless steel self drilling screws. The Engineer of Record

(EOR) is encouraged to investigate the uplift forces due to wave action, if present, prior to establishing the connection intervals.

In some situations caps are not recommended due to excessive uplift caused by waves.

Sheet pile connectors are available for each sheet pile section for making 45° and 90° wall alignments. The 1580 sheet pile connector will permit 45°/90° and 180° connections.

Part drawings for the accessories can be viewed at CreativeCompositesGroup.com

Top Caps:

Note: Consult a professional engineer when concerns of wave loads are involved.

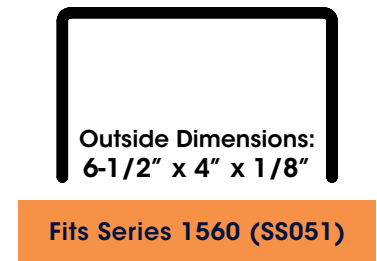
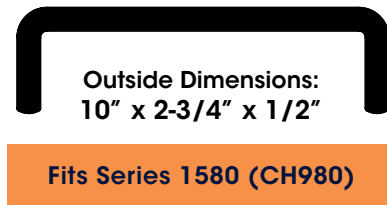
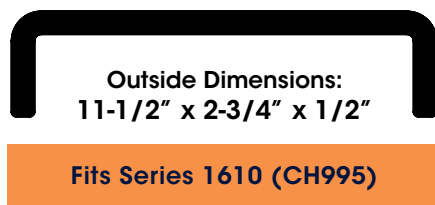

Connectors:

45°/90°/180°

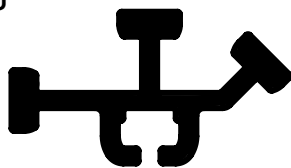

45°/90°



45°/90°/180°
Made of PVC

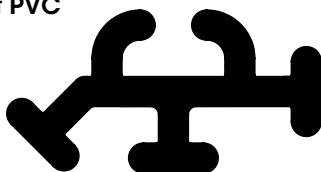

45°/90°

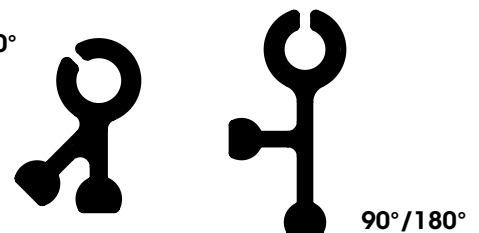



SuperLoc Specifications

The EOR should specify FRP sheet piling based on the latest standards and codes within the pultrusion industry. The proper specifications will protect the owner, EOR and the manufacturer. The specifications will effectively communicate the manufacturing and material property expectations to all involved.

CCG strongly recommends that the specification mandate that all material properties be characterized per ASTM D7290-06.

The minimum moment, shear and Modulus of Elasticity (MOE) should be specified based on the requirements of your project.

CCG strongly encourages the EOR to scrutinize the safety factors and methods used for determining the moment capacities that have been published by FRP sheet pile manufacturers.

*Contact CCG for AutoCad files, part drawings and specifications.

Part drawings can be viewed at:
CreativeCompositesGroup.com

1.0 SCOPE

This specification applies to the mechanical, physical and visual requirements of FRP sheet piling.

2.0 MECHANICAL PROPERTIES

2.1 The mechanical design properties shall be published as a characteristic value per the requirements of ASTM D7290-06.

2.2 The lengthwise and transverse tensile modulus and strength shall be determined by testing per ASTM D638.

2.3 The lengthwise and transverse compression modulus and strength shall be determined by testing per ASTM D6641.

2.4 The in-plane shear strength and modulus shall be determined by testing per ASTM D5379.

2.5 The fiber reinforcements shall meet the minimum tensile strength of 290 ksi per ASTM D2343.

3.0 VISUAL REQUIREMENTS

3.1 Visual requirements shall be as prescribed in ASTM D4385.

3.2 Sheet pile sections shall contain UV light absorbers and stabilizers and a 3 mil polyester or nylon veil that encapsulates the glass fibers to diminish the possibility of fiber blooming.

4.0 DIMENSIONAL REQUIREMENTS

4.1 Per ASTM D3917.

5.0 QUALITY ASSURANCE

5.1 Quality Assurance shall be performed as described in the manufacturer's quality plan as approved by the EOR.

Installation of SuperLoc

SuperLoc sheet piles are commonly installed with vibratory driver/extractors.

SuperLoc sheet pile sections can be driven to elevation in clean sands and clay that exhibit a blow count N of 20 blows or less per foot as determined by the Standard Penetration Test (SPT). SuperLoc sheets have been driven in soils with blow counts ranging from 20 to 30 with the aid of excavation and or a steel mandrel. The steel mandrel is fabricated to mimic the profile shape of the sheet. The steel mandrel is driven into the soils ahead of the FRP sheets to punch a profile through the stiff soil prior to driving the FRP sheet.

**Blow count:
N<20**



Vibratory Hammer Installation Example

Depending on the drive ability and the hammer type, it is not uncommon for the sheet pile to display some signs of abrasion and mushrooming at the top due to the clamp pressure and vibration of the vibratory hammer. Most contractors will add some length of sheet and cut the sheets to grade after they have been installed.



Example of Clamp Pressure

When installing FRP sheet pile, please be sure to always lead with the male end. Leading with the female end will allow a soil plug to build in the groove and potentially damage the sheet pile during installation.

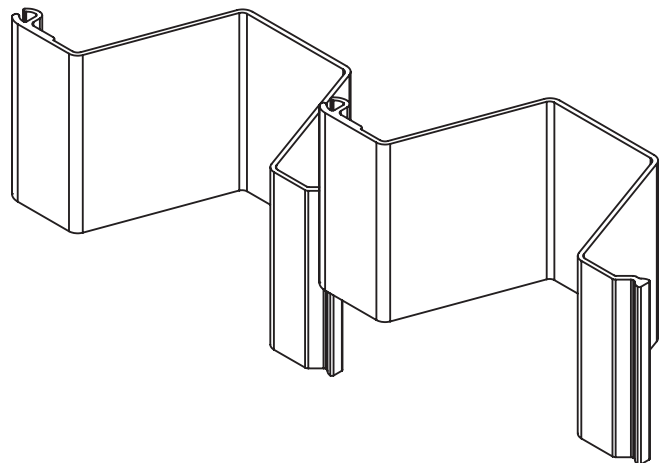

Drawing of Installation Example



Marina Installation
Wilmington, North Carolina

SuperWale Specifications

Extend The Life Of Your Bulkhead By Specifying SuperWale

SuperWale, like the SuperLoc sheet pile system, is manufactured with thermoset resins and high-strength E-glass, via the pultrusion process, making SuperWale the product of choice for the test of time. Engineers, architects, home owner associations and government agencies continue to specify SuperWale where low maintenance, aesthetics, and a superior design life are crucial to their projects. Your structure is only as strong as the weakest member. Extend the life of your bulkhead by specifying SuperWale.

The governing design capacity of SuperWale will be based on either the tie-rod spacing, flexural strength, shear strength, deflection, or washer pull through capacity. In most cases the point load being induced into the SuperWale, through the tie-rod, governs the tie-rod spacing and wale capacity. The designer is encouraged to pay particular attention to the

characteristic tie-rod force permitted on SuperWale in conjunction with the specified steel washer dimension. The characteristic tie-rod force is dependent on the resin selected for the wale section and the dimensions of the washer specified. The characteristic tie rod force applied into the SuperWale through the steel washer can be established by referencing the Characteristic Tie-rod Force on SuperWale with Specified Washers chart. The values are published as characteristic values therefore the appropriate resistance, ϕ , λ or safety factors need to be applied.

Wale splices are made with a galvanized 50 ksi steel section known as the SuperWale W-splice section. Tie-rods should be used in conjunction with the steel W-splice. Corners are fabricated with a 316 stainless steel fabricated section that is cut and fabricated to fit the angle of the corner. 316 stainless steel is utilized to allow for welding the fabricated section. Oversize steel washers must be utilized with every tie-rod in order for the SuperWale to perform to its optimal structural capacity.

Characteristic Tie-rod Force on SuperWale with Specified Washers (Safety Factor Required)		
Vinyl Ester Resin Specified in SuperWale lbs (kg)	Polyester Resin Specified in SuperWale lbs (kg)	Steel Washer Dimensions inches (mm)
45,000 (20,400)	36,000 (16,300)	3.25x6x.5 (82x152x12.7)
47,600 (21,600)	47,600 (21,600)	3.25x12x.75 (82x152x19)

SuperWale Physical & Mechanical Properties

The physical and mechanical property charts are provided so that the EOR can determine the allowable tie rod spacing while considering the bending, shear and serviceability requirements of the wale. The properties have been published as characteristic values per ASTM D7290-06.



Physical Properties	Units
Minor Section Modulus	14.40 in ³ (1.97E+07 mm ³)
Minor Moment of Inertia	49.22 in ⁴ (2.05E+07 mm ⁴)
Depth of Section	6.0 in. (152.4 mm)
Width of Section	8.0 in. (203.2 mm)
Weight	9.70 lb/ft. (14.44 kg/m)
Area of the web	4.9 in ² (3,160 mm ²)
Standard Color	Graphite Gray

Mechanical Properties Of Wale Section Bent About The Minor Axis	Test Method	Units	Polyester Resin Average Values	Vinyl Ester Resin Average Values
Modulus of Elasticity	Lab	Msi (GPa)	3.16 (21.8)	3.56 (24.5)
Shear Modulus	Lab	Msi (GPa)	0.45 (3.1)	0.45 (3.1)
Shear Capacity	Lab/Calculated	lb (kg)	31,600 (14,300)	44,100 (20,200)
Moment Capacity	Lab/Calculated	ft-lb (N-m)	41,600 (56,400)	42,400 (57,400)
Bending Stiffness EI Value	Calculated	lb-in ² (N-m ²)	1.56E8 (4.46E5)	1.75E8 (5.03E5)
In-Plane Shear Strength	ASTM D5379	ksi (MPa)	9.6 (66.2)	13.4 (92.4)

*Note: All values listed in the above table are characteristic values determined in accordance with ASTM D7290-06.

Example of Wale Installation

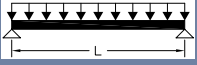

SuperWale Polyester Load Tables

Design Charts for SuperWale Specified with Polyester Resin Simply Supported, Simple Span Load Condition (Imperial Units)							
Tie-rod Spacing (ft)	Load on the wale that produces 0.25" deflection (lbs./ft)	Load on the wale that produces 0.375" deflection (lbs./ft)	Load on the wale that produces 0.5" deflection (lbs./ft)	Allowable Load per foot of wale (Flexure) (lbs/ft)	Allowable Load per foot of wale (Shear) (lbs/ft)	Allowable Load per foot of wale (Tie-rod Pull Force utilizing a 3.25"x6.0"x.50" steel washer) (lbs/ft)	Allowable Load per foot of wale (Tie-rod Pull Force utilizing a 3.25"x12"x.75" steel washer) (lbs/ft)
3	19,233	28,850	38,466	14,802	7,016	8,000	10,578
4	6,085	9,128	12,171	8,326	5,262	6,000	7,933
5	2,493	3,739	4,985	5,329	4,209	4,800	6,347
6	1,202	1,803	2,404	3,701	3,508	4,000	5,289
7	649	973	1,298	2,719	3,007	3,429	4,533
8	380	571	761	2,082	2,631	3,000	3,967
9	237	356	475	1,645	2,339	2,667	3,526
10	156	234	312	1,332	2,105	2,400	3,173

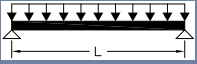
Design Charts for SuperWale Specified with Polyester Resin Simply Supported, Simple Span Load Condition (Metric Units)							
Tie-rod Spacing (m)	Load on the wale that produces 6mm deflection (kN/m)	Load on the wale that produces 10mm deflection (kN/m)	Load on the wale that produces 13mm deflection (kN/m)	Allowable Load per meter of wale (Flexure) (kN/m)	Allowable Load per meter of wale (Shear) (kN/m)	Allowable Load per meter of wale (Tie-rod Pull Force utilizing a 83x152x12.7mm steel washer) (kN/m)	Allowable Load per meter of wale (Tie-rod Pull Force utilizing a 83x305x19mm steel washer) (kN/m)
1.00	185.4	309.0	401.7	180.6	93.6	106.8	141.2
1.25	75.9	126.6	164.5	115.6	74.9	85.4	112.9
1.50	36.6	61.0	79.4	80.3	62.4	71.2	94.1
1.75	19.8	32.9	42.8	59.0	53.5	61.0	80.7
2.00	11.6	19.3	25.1	45.2	46.8	53.4	70.6
2.25	7.2	12.1	15.7	35.7	41.6	47.4	62.7
2.50	4.7	7.9	10.3	28.9	37.4	42.7	56.5
2.75	3.2	5.4	7.0	23.9	34.0	38.8	51.3

Notes: Safety Factors Include: 2.5 for Flexure, 3 for Shear, and 3 for washer pull through strength.

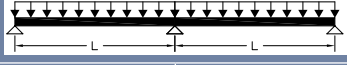
Design Charts for SuperWale Specified with Polyester Resin Simply Supported, Continuous Span Load Condition (Imperial Units)							
Tie-rod Spacing (ft)	Load on the wale that produces 0.25" deflection (lbs./ft)	Load on the wale that produces 0.375" deflection (lbs./ft)	Load on the wale that produces 0.5" deflection (lbs./ft)	Allowable Load per foot of wale (Flexure) (lbs/ft)	Allowable Load per foot of wale (Shear) (lbs/ft)	Allowable Load per foot of wale (Tie-rod Pull Force utilizing a 3.25"x6.0"x.50" steel washer) (lbs/ft)	Allowable Load per foot of wale (Tie-rod Pull Force utilizing a 3.25"x12"x.75" steel washer) (lbs/ft)
3	36,320	54,481	72,641	14,802	5,613	3,200	4,231
4	11,492	17,238	22,984	8,326	4,209	2,400	3,173
5	4,707	7,061	9,414	5,329	3,368	1,920	2,539
6	2,270	3,405	4,540	3,701	2,806	1,600	2,116
7	1,225	1,838	2,451	2,719	2,405	1,371	1,813
8	718	1,077	1,436	2,082	2,105	1,200	1,587
9	448	673	897	1,645	1,871	1,067	1,410
10	294	441	588	1,332	1,684	960	1,269

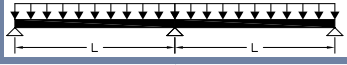
Design Charts for SuperWale Specified with Polyester Resin Simply Supported, Continuous Span Load Condition (Metric Units)							
Tie-rod Spacing (m)	Load on the wale that produces 6mm deflection (kN/m)	Load on the wale that produces 10mm deflection (kN/m)	Load on the wale that produces 13mm deflection (kN/m)	Allowable Load per meter of wale (Flexure) (kN/m)	Allowable Load per meter of wale (Shear) (kN/m)	Allowable Load per meter of wale (Tie-rod Pull Force utilizing a 83x152x12.7mm steel washer) (kN/m)	Allowable Load per meter of wale (Tie-rod Pull Force utilizing a 83x305x19mm steel washer) (kN/m)
1.00	350.1	583.6	758.6	180.6	74.9	42.7	56.5
1.25	143.4	239.0	310.7	115.6	59.9	34.2	45.2
1.50	69.2	115.3	149.9	80.3	49.9	28.5	37.6
1.75	37.3	62.2	80.9	59.0	42.8	24.4	32.3
2.00	21.9	36.5	47.4	45.2	37.4	21.4	28.2
2.25	13.7	22.8	29.6	35.7	33.3	19.0	25.1
2.50	9.0	14.9	19.4	28.9	30.0	17.1	22.6
2.75	6.1	10.2	13.3	23.9	27.2	15.5	20.5

Notes:

1. Safety Factors Include: 2.5 for Flexure, 3 for Shear, and 3 for washer pull through strength.
2. To ensure conservative values, 3 spans used for deflection calculations, and 2 spans used for strength calculations.

SuperWale Vinyl Ester Load Tables

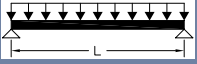
Design Charts for SuperWale Specified with Vinyl Ester Resin Simply Supported, Simple Span Load Condition (Imperial Units)							
Tie-rod Spacing (ft)	Load on the wale that produces 0.25" deflection (lbs./ft)	Load on the wale that produces 0.375" deflection (lbs./ft)	Load on the wale that produces 0.5" deflection (lbs./ft)	Allowable Load per foot of wale (Flexure) (lbs/ft)	Allowable Load per foot of wale (Shear) (lbs/ft)	Allowable Load per foot of wale (Tie-rod Pull Force utilizing a 3.25"x6.0"x.50" steel washer) (lbs/ft)	Allowable Load per foot of wale (Tie-rod Pull Force utilizing a 3.25"x12"x.75" steel washer) (lbs/ft)
3	21,668	32,501	43,335	15,058	9,793	10,000	10,578
4	6,856	10,284	13,712	8,470	7,345	7,500	7,933
5	2,808	4,212	5,616	5,421	5,876	6,000	6,347
6	1,354	2,031	2,708	3,765	4,896	5,000	5,289
7	731	1,096	1,462	2,766	4,197	4,286	4,533
8	428	643	857	2,118	3,672	3,750	3,967
9	268	401	535	1,673	3,264	3,333	3,526
10	176	263	351	1,355	2,938	3,000	3,173

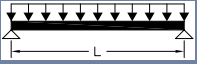
Design Charts for SuperWale Specified with Vinyl Ester Resin Simply Supported, Simple Span Load Condition (Metric Units)							
Tie-rod Spacing (m)	Load on the wale that produces 6mm deflection (kN/m)	Load on the wale that produces 10mm deflection (kN/m)	Load on the wale that produces 13mm deflection (kN/m)	Allowable Load per meter of wale (Flexure) (kN/m)	Allowable Load per meter of wale (Shear) (kN/m)	Allowable Load per meter of wale (Tie-rod Pull Force utilizing a 83x152x12.7mm steel washer) (kN/m)	Allowable Load per meter of wale (Tie-rod Pull Force utilizing a 83x305x19mm steel washer) (kN/m)
1.00	208.9	348.1	452.6	183.7	130.7	133.4	141.2
1.25	85.6	142.6	185.4	117.6	104.5	106.8	112.9
1.50	41.3	68.8	89.4	81.7	87.1	89.0	94.1
1.75	22.3	37.1	48.3	60.0	74.7	76.3	80.7
2.00	13.1	21.8	28.3	45.9	65.3	66.7	70.6
2.25	8.2	13.6	17.7	36.3	58.1	59.3	62.7
2.50	5.3	8.9	11.6	29.4	52.3	53.4	56.5
2.75	3.7	6.1	7.9	24.3	47.5	48.5	51.3

Notes: Safety Factors Include: 2.5 for Flexure, 3 for Shear, and 3 for washer pull through strength.

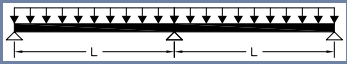
Design Charts for SuperWale Specified with Vinyl Ester Resin Simply Supported, Continuous Span Load Condition (Imperial Units)							
Tie-rod Spacing (ft)	Load on the wale that produces 0.25" deflection (lbs./ft)	Load on the wale that produces 0.375" deflection (lbs./ft)	Load on the wale that produces 0.5" deflection (lbs./ft)	Allowable Load per foot of wale (Flexure) (lbs/ft)	Allowable Load per foot of wale (Shear) (lbs/ft)	Allowable Load per foot of wale (Tie-rod Pull Force utilizing a 3.25"x6.0"x.50" steel washer) (lbs/ft)	Allowable Load per foot of wale (Tie-rod Pull Force utilizing a 3.25"x12"x.75" steel washer) (lbs/ft)
3	40,918	61,377	81,836	15,058	7,834	4,000	4,231
4	12,947	19,420	25,893	8,470	5,876	3,000	3,173
5	5,303	7,954	10,606	5,421	4,701	2,400	2,539
6	2,557	3,836	5,115	3,765	3,917	2,000	2,116
7	1,380	2,071	2,761	2,766	3,358	1,714	1,813
8	809	1,214	1,618	2,118	2,938	1,500	1,587
9	505	758	1,010	1,673	2,611	1,333	1,410
10	331	497	663	1,355	2,350	1,200	1,269

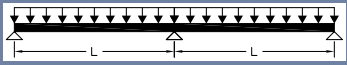
Design Charts for SuperWale Specified with Vinyl Ester Resin Simply Supported, Continuous Span Load Condition (Metric Units)							
Tie-rod Spacing (m)	Load on the wale that produces 6mm deflection (kN/m)	Load on the wale that produces 10mm deflection (kN/m)	Load on the wale that produces 13mm deflection (kN/m)	Allowable Load per meter of wale (Flexure) (kN/m)	Allowable Load per meter of wale (Shear) (kN/m)	Allowable Load per meter of wale (Tie-rod Pull Force utilizing a 83x152x12.7mm steel washer) (kN/m)	Allowable Load per meter of wale (Tie-rod Pull Force utilizing a 83x305x19mm steel washer) (kN/m)
1.00	394.5	657.4	854.7	183.7	104.5	53.4	56.5
1.25	161.6	269.3	350.1	117.6	83.6	42.7	45.2
1.50	77.9	129.9	168.8	81.7	69.7	35.6	37.6
1.75	42.1	70.1	91.1	60.0	59.7	30.5	32.3
2.00	24.7	41.1	53.4	45.9	52.3	26.7	28.2
2.25	15.4	25.7	33.3	36.3	46.5	23.7	25.1
2.50	10.1	16.8	21.9	29.4	41.8	21.4	22.6
2.75	6.9	11.5	14.9	24.3	38.0	19.4	20.5

Notes:

1. Safety Factors Include: 2.5 for Flexure, 3 for Shear, and 3 for washer pull through strength.
2. To ensure conservative values, 3 spans used for deflection calculations, and 2 spans used for strength calculations.

Data and Testing Information

The SuperWale was tested in a full section scenario, in independent labs, to determine the full section modulus of elasticity, moment capacity, shear capacity and tie rod punch through strength.

Moment Capacity

The moment capacity was determined by several full section tests configured in a three-point bend scenario. Sufficient data was collected to calculate the characteristic value via ASTM D7290, which provides an 80% lower confidence bound on the 5th percentile value. These values should be used in conjunction with the load combinations, adjustment factors, and phi factors set forth in the Pre-Standard for Load and Resistance Factor Design (LRFD) of Pultruded Fiber Reinforced Polymer (FRP) Structures developed by ASCE.



The wale sections were loaded until failure in a 3-point bend configuration utilizing an 8' span. The average failure load was recorded to be 24,135 lbs. The corresponding moment was determined to be 48,271 ft-lbs. When analyzed in accordance with ASTM D7290 the characteristic moment capacity is calculated to be 41,600 ft-lbs.

Shear Capacity Of The SuperWale

The ultimate shear capacity was determined by the utilization of the following shear equation:

$$\text{Where, } \tau_{xy} = \frac{3}{2} \frac{V}{A_w}$$

$$\tau_{xy} = 9,600 \text{ psi, Shear Stress (psi)}$$

$$V = \text{Shear Load (lbs.)}$$

$$A_w = 4.9 \text{ in}^2, \text{ Area of the web (in}^2\text{)}$$

The ultimate shear load V was calculated to be 31,571 lbs.

The shear values shown in the load tables are calculated using the characteristic shear strength of the webs when tested with ASTM D5379. The resulting data was then analyzed, as specified, by ASTM D7290 to determine the characteristic value of Shear Stress τ_{xy} .

Tie-Rod Capacity

The tie-rod capacity is subject to the tie-rod connection detail. The washer size greatly influences the capacity of the SuperWale system. Punch through tests have been conducted on the SuperWale section with various washer configurations.

The test involved drilling a 1.25" diameter hole in the middle of the wale section and inserting an FRP nut and stud through the hole in the washer as depicted in Figure 1. Various washer sizes were tested to determine the appropriate washer dimensions.

A load was then induced onto the nut utilizing an Instron testing machine. The load and deflection was recorded until a failure occurred. Failure was defined as permanent distortion or when audible/visual cracking was detected.

The following chart reflects the allowable tie-rod force with various washers. CCG only recommends the washer dimensions specified below. Alternative washer dimensions are only to be used at the discretion of the practicing engineer.



Figure 1. Photo of the Tie-rod push through test conducted in CCG Lab.

Characteristic Tie-rod Force on SuperWale with Specified Washers (Safety Factor Required)		
Vinyl Ester Resin Specified in SuperWale lbs (kg)	Polyester Resin Specified in SuperWale lbs (kg)	Steel Washer Dimensions inches (mm)
45,000 (20,400)	36,000 (16,300)	3.25x6x.5 (82x152x12.7)
47,600 (21,600)	47,600 (21,600)	3.25x12x.75 (82x152x19)

Example of Wale Installation



SuperWale Accessories

Part drawings can be viewed at: CreativeCompositesGroup.com

W-Splice



SuperWale W-Splice

Part Number	Material	Dimension	Weight
FAB383	50 ksi structural steel galvanized per ASTM A123	12L x 8.4W (305x213) in(mm) Hole diameter 1.125 (28.58) in(mm)	11 lbs. (5 kg)

Engineering Notes:

1. Tie-rod must be backed with a 3x3x.25 (83x83x6) in(mm) galvanized per ASTM A123 steel washer.
2. A tie rod should be utilized with each splice.
3. The working load capacity of the wale splice is 20,000 lbs., which includes a service factor.

W-Corner Connector



SuperWale W-Corner Connector

Part Number ¹	Material	Dimension	Weight
FAB093 - 90° FAB094 - 45°	316 Stainless Steel ²	Both sides 12L x 8.4W (304.8x 213.4) in(mm) Hole Diameter drilled at 13/16" (20.64) for a .75x4.5 (19.05x114.3) in(mm) bolt	23 lbs. (10 kg)

Engineering Notes:

1. Special angles are available upon request.
2. Parts can be factory or field welded.

Steel Washers



SuperWale Steel Washers

Part Number	Material	Dimension	Weight
FAB384	50 ksi steel galvanized per ASTM A123	3.25x6x.5 (82x152x12.7) in(mm) Hole diameter 1.125 (28.58) in(mm)	2.75 lbs. (1.25 kg)
FAB385	50 ksi steel galvanized per ASTM A123	3.25x12x.75 (82x305x19) in(mm) Hole diameter 1.125 (28.58) in(mm)	8.35 lbs. (3.79 kg)

Cutting and Drilling Instructions

Cutting Sheets, Wales and Accessories

SuperLoc can be field cut with a concrete, skill or reciprocating saw. An abrasive blade should always be used. Concrete saws work the best and can be utilized with a standard concrete cutting blade.

During drill and sawing operations, dust will be emitted. The dust is considered a nuisance dust, which can irritate your eyes and skin. Therefore, safety glasses, gloves and long sleeve shirts are recommended during the cutting and drilling process.

As documented by OSHA, FRP dust millings have potential to cause eye, skin, and upper respiratory tract irritation.

- Cause - mechanical-irritant properties of the glass fibers.
- FRP particulate is non-hazardous.
- FRP particulate is greater than 6 microns; therefore, it cannot reach the alveoli.
- The International Agency for Research on Cancer (IARC) classified FRP particulate as non-cancer causing in June of 1987.



Example of a Concrete Saw

Drilling Sheets, Wales and Accessories

SuperLoc and its accessories can be drilled with carbide tipped drill bits. CCG recommends fiberglass hollow pole drill bits or carbide tipped drill bits for applications that require multiple holes in a short period of time.



Fiberglass Drill Bit

Choose Creative Composites Group for Comprehensive Project Support

Your Single Source for Innovative Engineered Waterfront Solutions Using StormStrong FRP Composites

Advance your products and projects beyond the limitations of traditional concrete, steel and wood by leveraging the combined strength of Creative Composites Group. We are a leader in technical innovation that is backed by the industry's most comprehensive FRP manufacturing group for infrastructure.

Creative Composites Group can help you engineer and manufacture waterfront infrastructure projects to ensure durability and protection against extreme weather with our StormStrong products.

Other companies commoditize FRP in off-the-shelf shapes and forms; Creative Composites Group does not. We offer comprehensive engineering, design and consultation for shoreline and asset protection. Our manufacturing capabilities include the broadest range of StormStrong FRP solutions to build your ideal projects. That's possible only with our proven engineering processes, end-to-end collaboration, service and support resources. Since StormStrong FRP composites last longer than conventional materials they often have a lower lifetime cost when you consider longer service life and low to no maintenance costs.



Discover Your Custom Engineered FRP Waterfront Infrastructure Provider

Creative Composites Group is committed to becoming a trusted business partner who is keenly interested in your project's success. Creative Composites Group works alongside your team, from facility owners to design engineers and contractors, to help you develop a customized FRP solution that meets the most demanding structural requirements and environmental conditions.

Contact us for your next engineered FRP sea wall or waterfront infrastructure project. We'd be thrilled to discuss it with you.



Creative Composites Group

888-274-7855

214 Industrial Lane
Alum Bank, PA 15521

CreativeCompositesGroup.com

DLR06152023R3
©2023 Creative Composites Group Inc.
All Rights Reserved Worldwide